

Vickers®

Servo Valves



SM4-20 (-50 Design) Servovalves

Flows to 76 l/min (20 USgpm) — Pressures to 350 bar (5000 psi)



Introduction

Vickers SM4-20 (-50 design) servovalves can provide system closed loop control with exact positional accuracy, repeatable velocity profiles, and predictable force or torque regulation. Typical applications include automatic gage control (AGC), roll bend/roll balance systems, plastic injection molding systems, test and simulation equipment, and hydraulic press brakes.

The high performance SM4-20 (-50 design) offers a wide range of rated flows from 3,8 to 76 l/min (1.0 to 20 USgpm) at Δp of 70 bar (1000 psi). The -50 design valve is designed for a maximum supply pressure of 350 bar (5000 psi).

The SM4-20 (-50 design) is a two-stage, modular design, flow control valve which can be manifold or subplate mounted.

The first stage consists of a symmetrical torque motor with dual coils and quad air gaps, flapper-nozzle pilot, and a centering feedback spring. An integral 35 micron absolute filter reduces sensitivity to contamination of the first stage.

The second stage utilizes a four-way sliding spool and sleeve arrangement with a mechanical null adjust. Spool position is fed back to the first stage by means of a cantilever spring.

An SM4-20 (-50 design) servovalve — when used with a hydraulic cylinder, position transducer, and appropriate electronics — can provide infinite cylinder position control to within 0,025 mm (0.001 in) or better, depending on components selected, length of stroke, and load characteristics.

When applied with servo hydraulic motors using tachometers and appropriate electronics, the SM4 provides infinite proportional flow control for realtime velocity/acceleration profiles. The resulting closed loop system can be error corrected to within one-tenth of a revolution per minute. With appropriate pressure transducers or load cells in force control applications, the SM4-20 (-50 design) makes possible exact load pressure/force control. In addition, excellent system stability with pressure and load to $\pm 1\%$ full scale can be achieved.

The field-proven design of the SM4-20 (-50 design) servovalve, combined with Vickers precision manufacturing techniques, provides you with the optimum in system control.

Features and Benefits

- The SM4-20 (-50 design) features a special stainless steel body and end caps for operating pressures up to 350 bar (5000psi).
- An integral filter for extra first stage contamination protection greatly reduces the likelihood of hard-over failures.
- Higher frequency response is available on request. This provides enhanced system bandwidth for critical performance requirements.
- The wide range of SM4-20 (-50 design) flow capabilities allow selection of the valve size best suited for an application.
- Jeweled orifices greatly extend the life of the valve.
- The balanced dual-coil, twin air gap, sealed torque motor in Vickers servovalves with its extremely fast response to input signals results in highly accurate control profiles.
- The exclusive jeweled feedback ball receiver virtually eliminates the wear that can lead to loss of control across null in other servovalves.
- Viton* seals are standard.
- The interchangeability made possible by standardized valve port circles, mounting patterns, and adapter manifolds makes Vickers servovalves the perfect choice for cost effective enhancement of existing systems.
- The SM4-20 (-50 design) can be interfaced to an available dual filter module to provide extra protection against pilot stage contamination.
- Customized spool lap and sleeve porting are available to provide the specific flow control required for special applications.
- The spool and sleeve are made of hardened steel and mounted with O-rings to minimize material erosion and eliminate spool binding, thus ensuring smooth operation.
- The SM4-20 (-50 design) is available with an optional pilot pressure port that provides either additional first stage filtration or the use of external pilot pressure for freedom from supply pressure fluctuations.
- Flushing valves are available to reduce initial system contamination levels prior to SM4 installation.

* Viton is a registered trademark of the DuPont Co.

Contents

Operating Data	2
Performance Curves	6
Model Code	10
Installation Dimensions	12
SM4M(E) Mounting Subplates	13
SM4A Adapter Manifolds	15
SM4FV Flushing Valves	17
SM4FM Filter Modules	18
Weights	19
Additional Accessories	19
Application Data	20

Cross Section of Typical SM4-20 (-50 Design) Servovalve

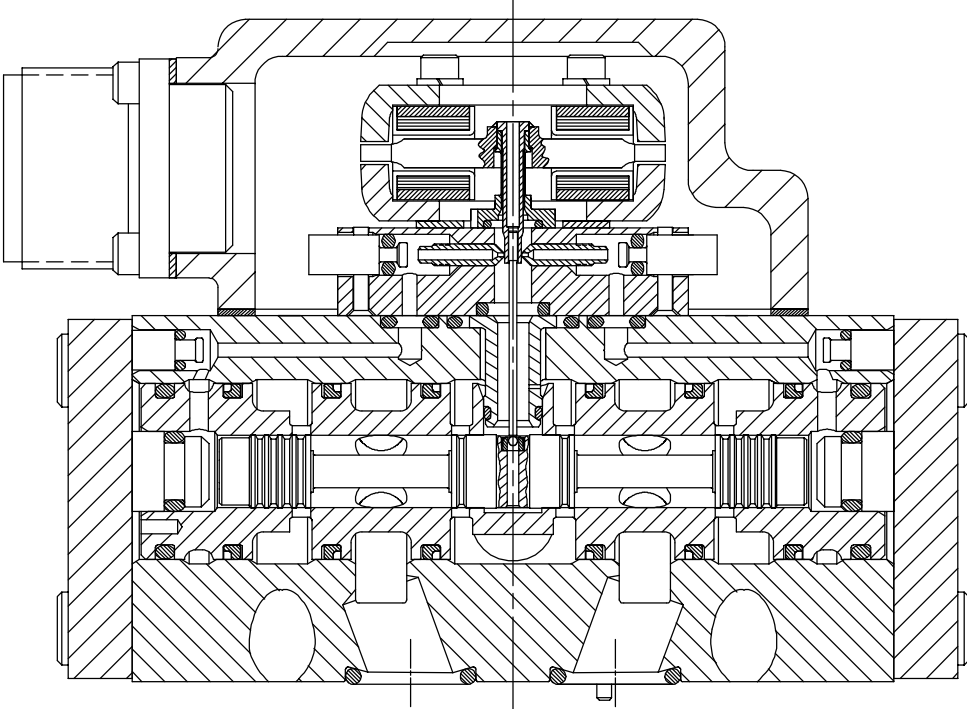

Operating Data

Flow and Leakage

All data is typical, based on actual tests at 70 bar (1000 psi) Δp , 30 cST (141 SUS), and 49°C (120°F).

Model Series	Maximum Rated Flow $\pm 10\%$ l/min (USgpm)	Maximum Total Null Leakage l/min (USgpm)	Maximum Pilot Flow at 70 bar (1000 psi) Δp l/min (USgpm)
SM4-20 (-50 design)	76 (20)	2,00 (0.52)	0,35 (0.092)

Performance

Maximum Supply Pressure bar (psi)	350 (5000)
Minimum Supply Pressure bar (psi)	14 (200)
Proof Pressure % maximum supply pressure	At Supply Port: 150 At Return Port: 100
Burst Pressure, Return Port Open % maximum supply pressure	250
Maximum Operating Temperature °C (°F)	135 (275)
Hysteresis Around Null % of rated current	≤ 3
Symmetry Error % of rated current	< 10
Linearity Error % of rated current	< 10
Threshold % of rated current	≤ 0.5

Ruggedness Test Results

Vibration Test 5 Hz to 2000 Hz along each axis	No damage to components
Shock Test Up to 150g along all axes	No damage to components
Endurance Test To ISO 6404	No degradation in performance

Flow Gain

Normal region for standard models shown with typical no-load flow gain tolerances excluding hysteresis.

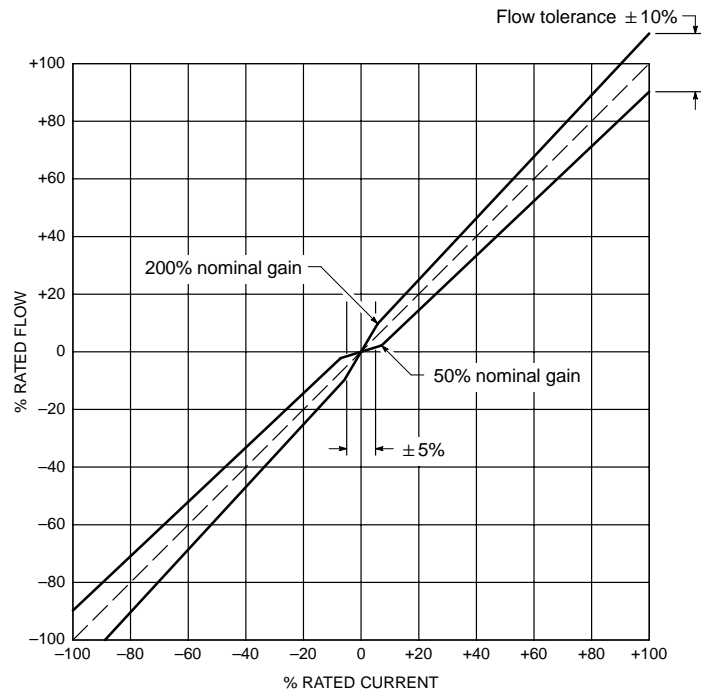

Pressure Gain

Change in load pressure drop with input current shown with no valve flow and closed control ports.

Pressure gain in the null region is $>30\%$ of supply pressure per 1% of rated current.

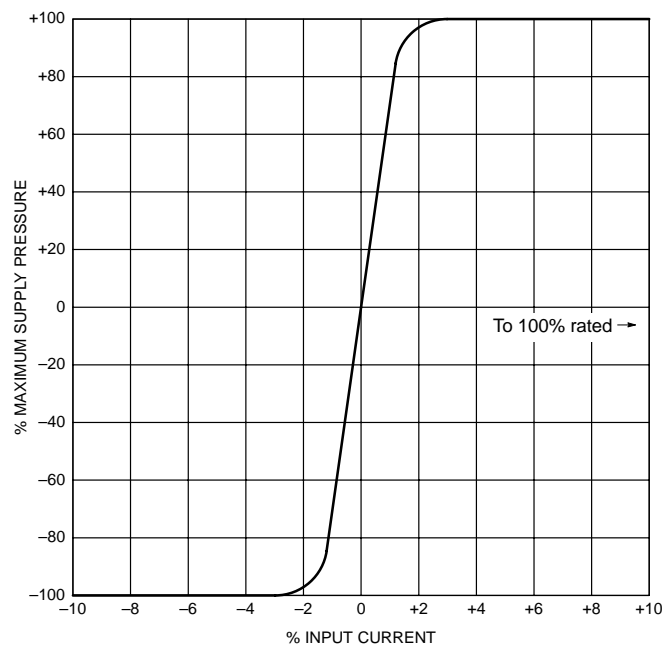

Change in Rated Flow

Rated flows at valve pressure drops from 5 bar (70 psi) to 350 bar (5000 psi) for eight of the available spools.

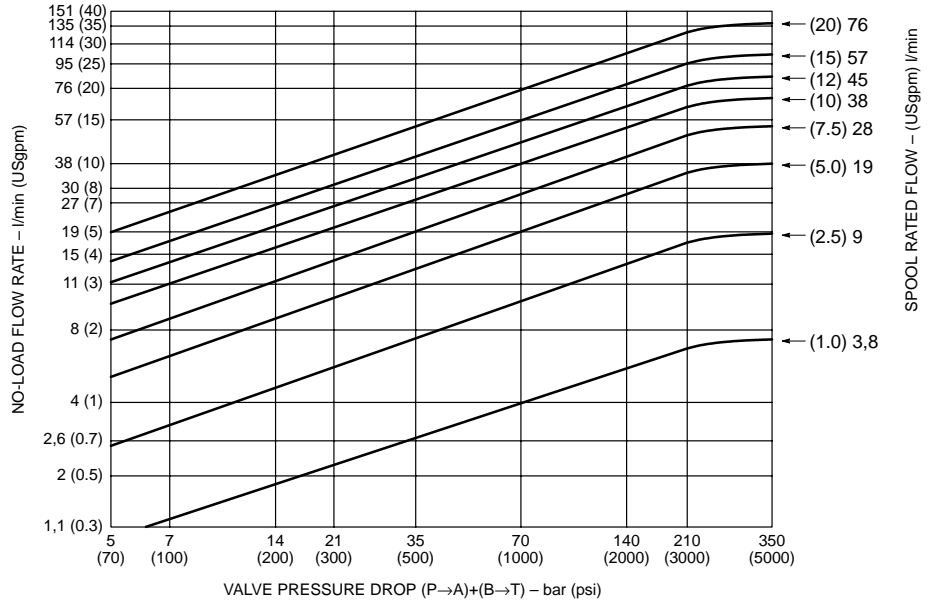

Power Transmission Efficiency

Maximum power envelope expressed as a percentage with T port pressure equal to 0 bar.

Power transferred to the load is optimum when valve pressure drop is one third of supply pressure. Load pressure drop should be limited to $\frac{2}{3}$ of supply pressure so the flow gain of the servovalve remains high enough to maintain control of the load. Overall hydraulic efficiency must be considered when sizing system heat exchangers.

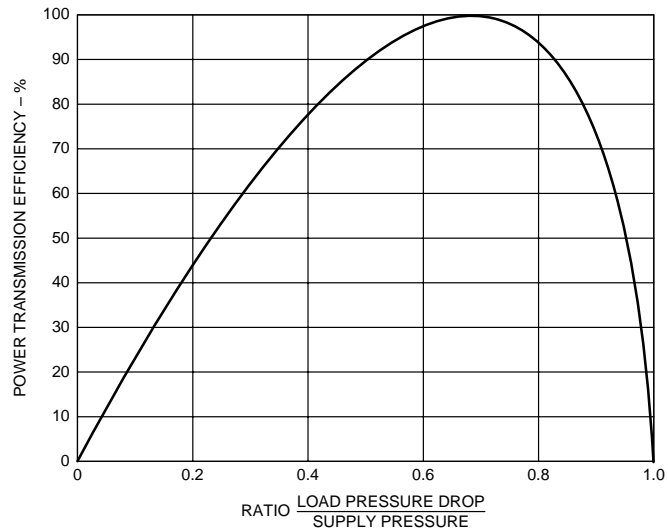

Coil Resistance

Select coil resistance and connections for compatible interface to servo electronics. **Recommended coil resistance is shown in bold print.**

	Nominal Resistance Per Coil at 21°C (70°F) Ohms	Rated Current mA	
		Single, Parallel, or Differential Connection	Series Connection
Standard coil resistance selection	20	200	100
	30	100	50
	80	40	20
	200	20	10
Optional coil resistance selection	80	50	25
	140	40	20
	200	15	7.5
	300	30	15
	1000	10	5
	1500	8	4

Electrical Polarity for Control Flow Out of B Port

Single:

A+, B-
or
C+, D-

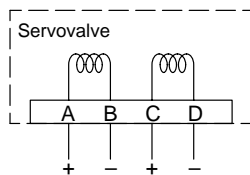

Parallel:

A+, C+
B-, D-
Connect A and C
Connect B and D

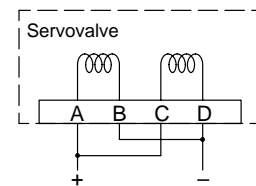

Series:

A+, D-
Connect B and C

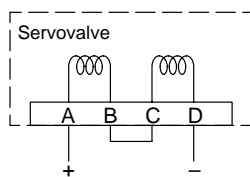

Differential:

A-, D-
B+, C+
Connect B and C
BC-, current BA>CD
BC+, current CD>BA

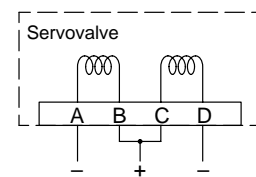

Performance Curves

Frequency Response

Frequency response is defined as the relationship of no-load control flow to input current with a sinusoidal current sweep at constant amplitude over a range of frequencies. It is expressed in frequency (Hz), amplitude ratio (dB), and phase angle (degrees).

Vickers SM4 torque motors are magnetically stabilized for reliable servovalve performance at operating pressures from 14 to 350 bar (200 to 5000 psi).

As shown in the sample curve (below left), the standard comparison point is -3 dB amplitude ratio, and 90° phase angle is a measure of the servovalve bandwidth.

Frequency response is lower for increased valve flow rates because of changes in internal design, such as spool and sleeve diameters, flapper nozzle assembly, and feedback spring rates.

Calculating Frequency Response at System Pressure

P_S = System pressure

P_M = Reference pressure of valve:
210 bar (3000 psi) for SM4-20 (-50 design)

f_{PM} = Frequency (at 90° phase angle) at reference pressure (P_M)

f_{PS} = Frequency (at 90° phase angle) at system pressure (P_S)

1. Calculate the ratio of system pressure to reference pressure:

$$\frac{P_S}{P_M}$$

2. Use the result of step 1 and the curve below to estimate

$$\frac{f_{PS}}{f_{PM}}$$

3. Use the applicable frequency response curve from the following pages to estimate f_{PM} (the reference pressure frequency response at 90° phase angle) for the desired valve rated flow.

4. Multiply the values obtained in steps 2 and 3. The result is f_{PS} (system pressure frequency response at 90° phase angle).

Example: An SM4-20-50 valve with a flow of 38 l/min (10 USgpm) is to be used at 275 bar (4000 psi).

1. Calculate the ratio of system pressure to reference pressure:

$$\frac{P_S}{P_M} = \frac{4000 \text{ psi}}{3000 \text{ psi}} = 1.33$$

2. Use the result of step 1 and the curve below right to estimate

$$\frac{f_{PS}}{f_{PM}} = 1.1$$

3. Use the frequency response curve from page 7 to estimate f_{PM} .

$$f_{PM} = 120 \text{ Hz}$$

4. Multiply the values obtained in steps 2 and 3. The result is f_{PS} (system pressure frequency response at 90° phase angle).

$$f_{PS} = 1.1 \times 120 \text{ Hz} = 135 \text{ Hz}$$

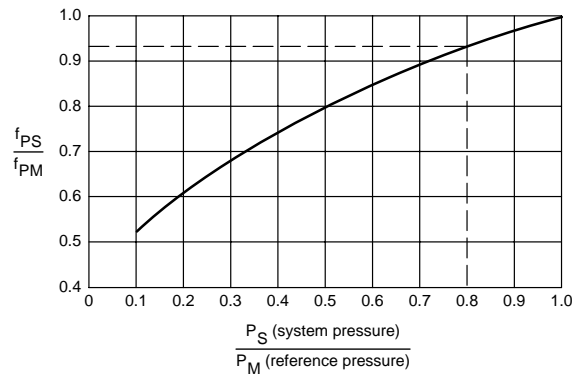
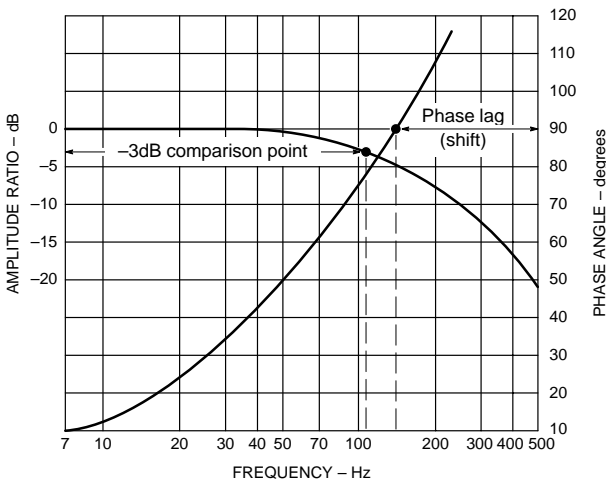

Typical Frequency Response Curves for Standard Models

SM4-20 (-50 design) shown at 210 bar (3000 psi) reference pressure

3,8 l/min (1.0 USgpm)

9 l/min (2.5 USgpm)

19 l/min (5.0 USgpm)

28 l/min (7.5 USgpm)

— ±40% rated current
 - - - ±100% rated current

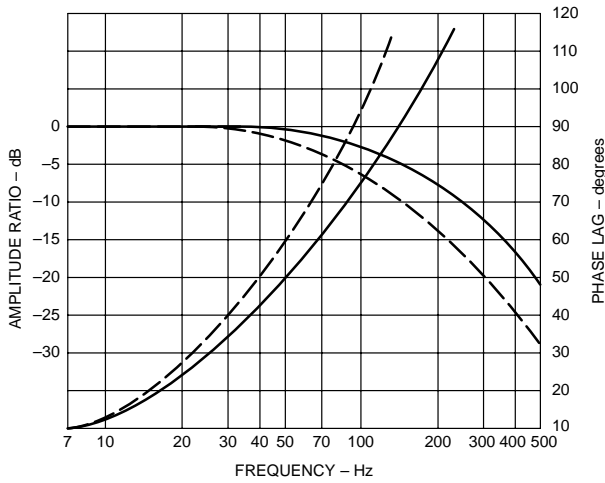

38 l/min (10 USgpm)

— ±40% rated current
 - - - ±100% rated current

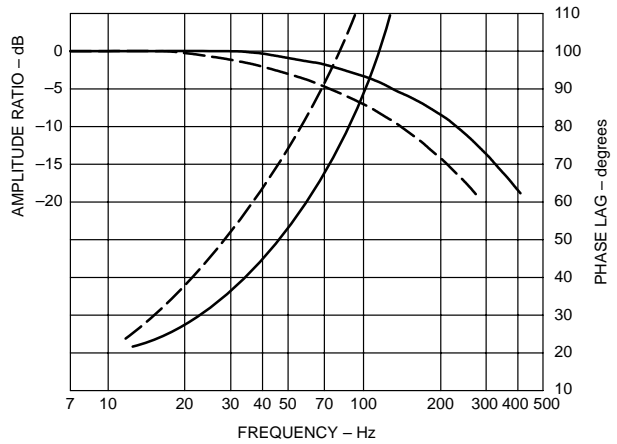

47 l/min (12.5 USgpm)

— ±40% rated current
 - - - ±100% rated current

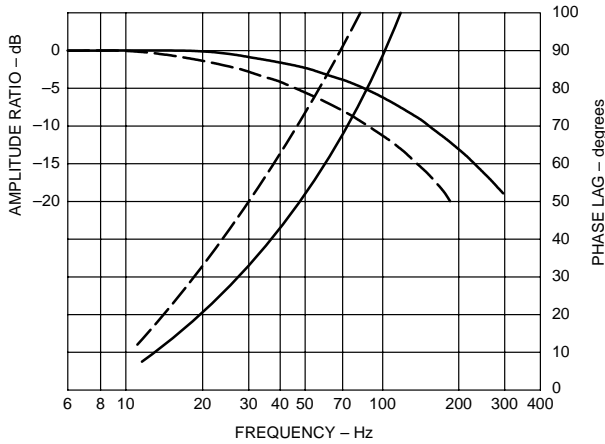

57 l/min (15 USgpm)

76 l/min (20 USgpm)

— ±40% rated current
 - - - ±100% rated current

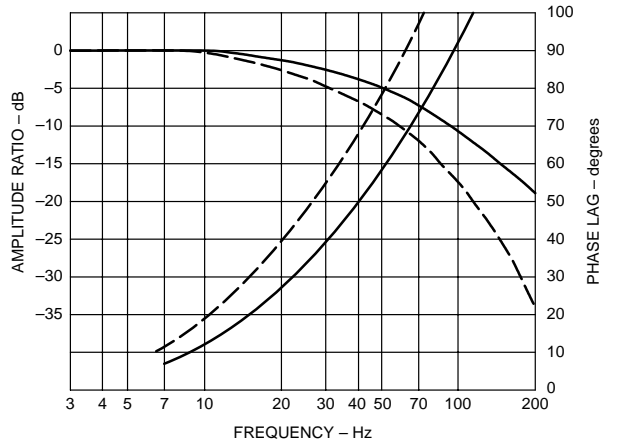

Step Response

Step response is defined as the typical rise time needed to achieve a given percentage of control flow output. Settling time is the time needed for transient flow fluctuations to diminish to within a given accuracy range. Both are expressed in milliseconds (ms).

The example shows the step response curves for a critically damped valve and an underdamped valve. Rise times are illustrated for 63% of control flow output, and settling times are shown at $100 \pm 5\%$ of control flow output.

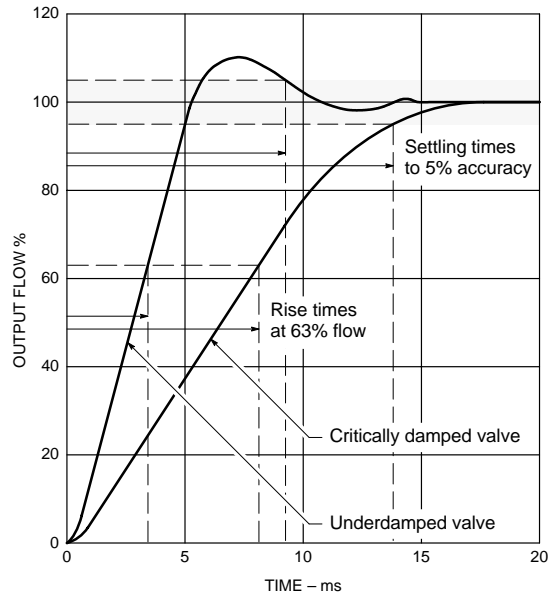

Typical Step Response Curves for Standard Models

SM4-20 shown at 210 bar (3000 psi) reference pressure

3,8 l/min (1.0 USgpm)
 9 l/min (2.5 USgpm)
 19 l/min (5.0 USgpm)
 28 l/min (7.5 USgpm)

38 l/min (10 USgpm)

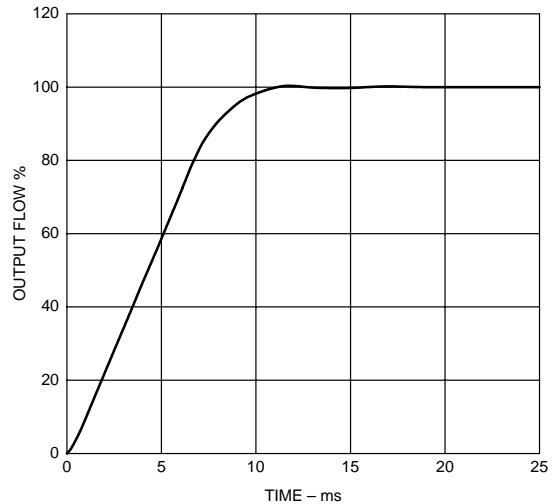
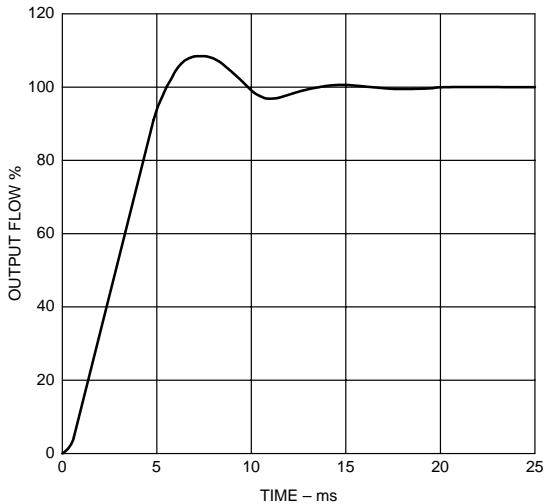

47 l/min (12.5 USgpm)
57 l/min (15 USgpm)

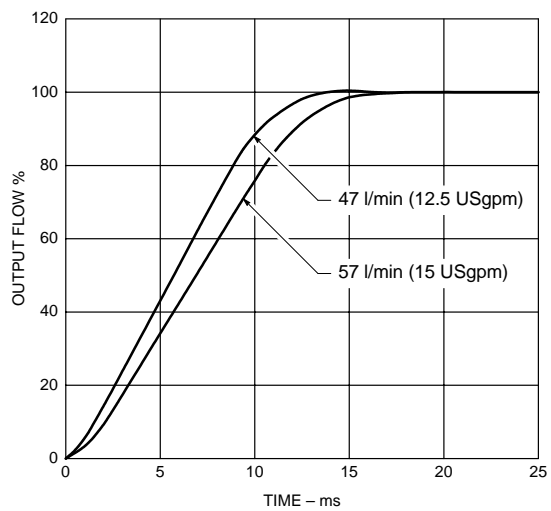

76 l/min (20 USgpm)

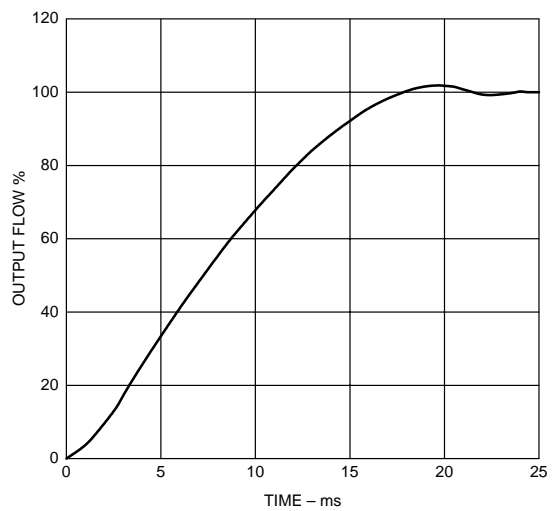

Model Code

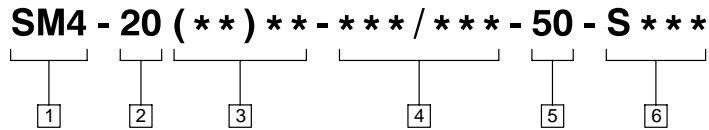

1 Series designation

SM4 – Servovalve, high performance, four-way

2 Valve size

20 – 22,2 mm (0.875 in) port circle

3 Flow rating

At 70 bar (1000 psi) Δp P→A→B→T.
Other flows available on request.

Code	USgpm	l/min
(1) 3,8	1.0	3,8
(2.5) 9	2.5	9
(5) 19	5.0	19
(7.5) 28	7.5	28
(10) 38	10.0	38
(12) 45	12.0	45
(12.5) 47	12.5	47
(15) 57	15.0	57
(20) 76	20.0	76

4 Coil resistance/rated current

Ohms/mA at 21°C (70°F). Other coils available on request.

Code	Ohms	mA
20/200	20	200
30/100	30	100
80/40	80	40
80/50	80	50
140/40	140	40
200/15	200	15
200/20	200	20
300/30	300	30
1000/10	1000	10
1500/8	1500	8

5 Design number

Subject to change. Installation dimensions same for designs 50 through 59.

-50 design indicates 350 bar (5000 psi) maximum supply pressure.

6 Special features suffix

S*** – Vickers assigns a unique suffix to denote a particular group of customized features. Contact your Vickers representative for details.

Blank – Standard valve

SM4M(E) Mounting Subplates

Model Code

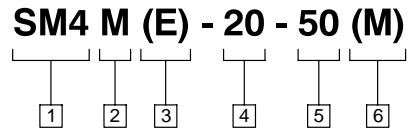

1 Series designation

SM4 – Servovalve, high performance, four-way

3 Port connection locations

Blank – Rear ports
E – Side ports

5 Design number

Subject to change. Installation dimensions same for designs 50 through 59.

2 Accessory designation

M – Mounting subplate. Maximum supply pressure of 350 bar (5000 psi).

4 Standard SM4 valve size

20 – SM4-20

-50 design indicates 350 bar (5000 psi) maximum supply pressure.

6 Metric suffix

M – Metric version to NG (ISO) standards
Blank – Omit if not required

SM4M(E) Mounting Subplates

Installation Dimensions

millimeters (inches)

SM4M-20-50(M)

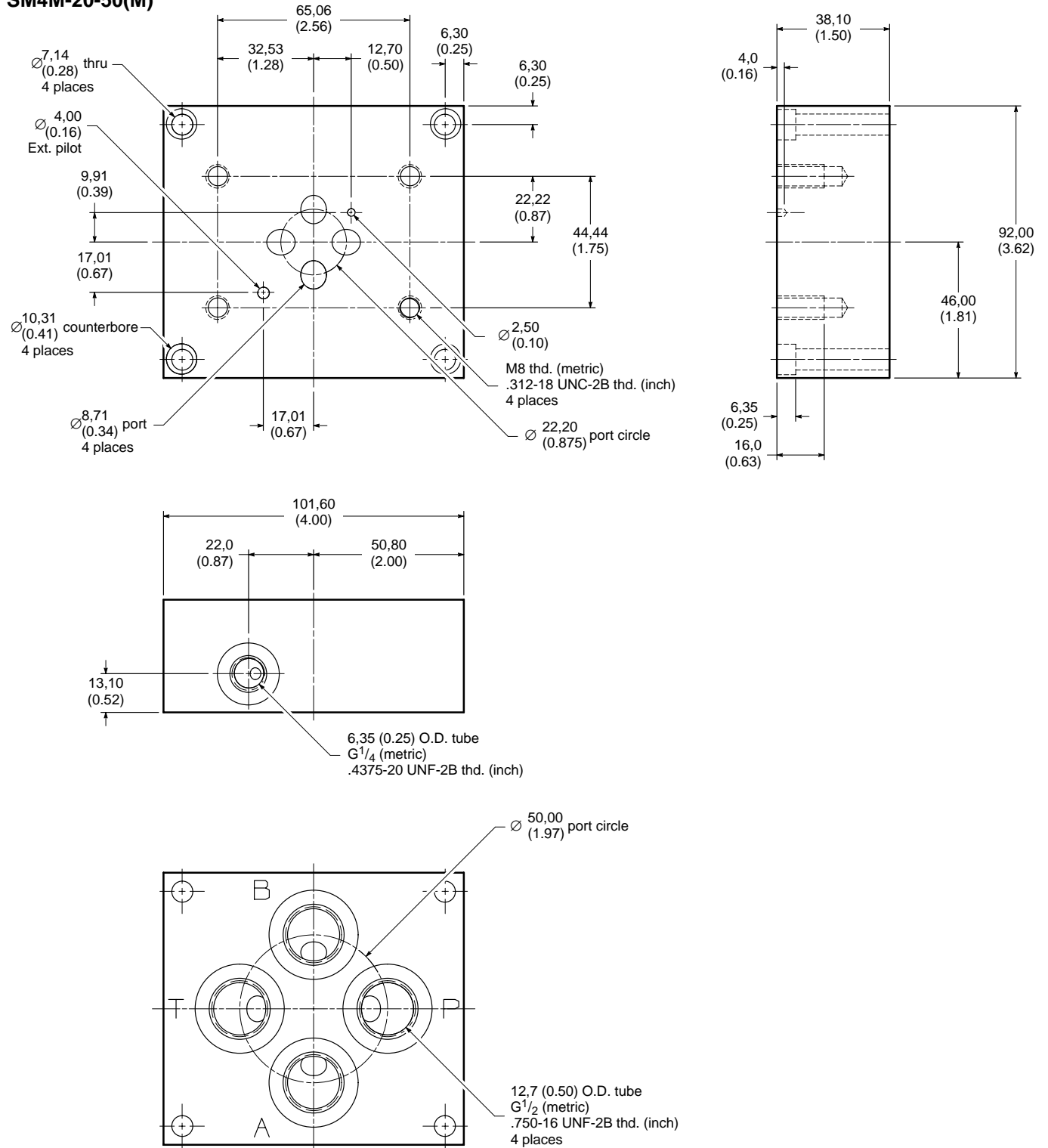

millimeters (inches)

SM4ME-20-50(M)

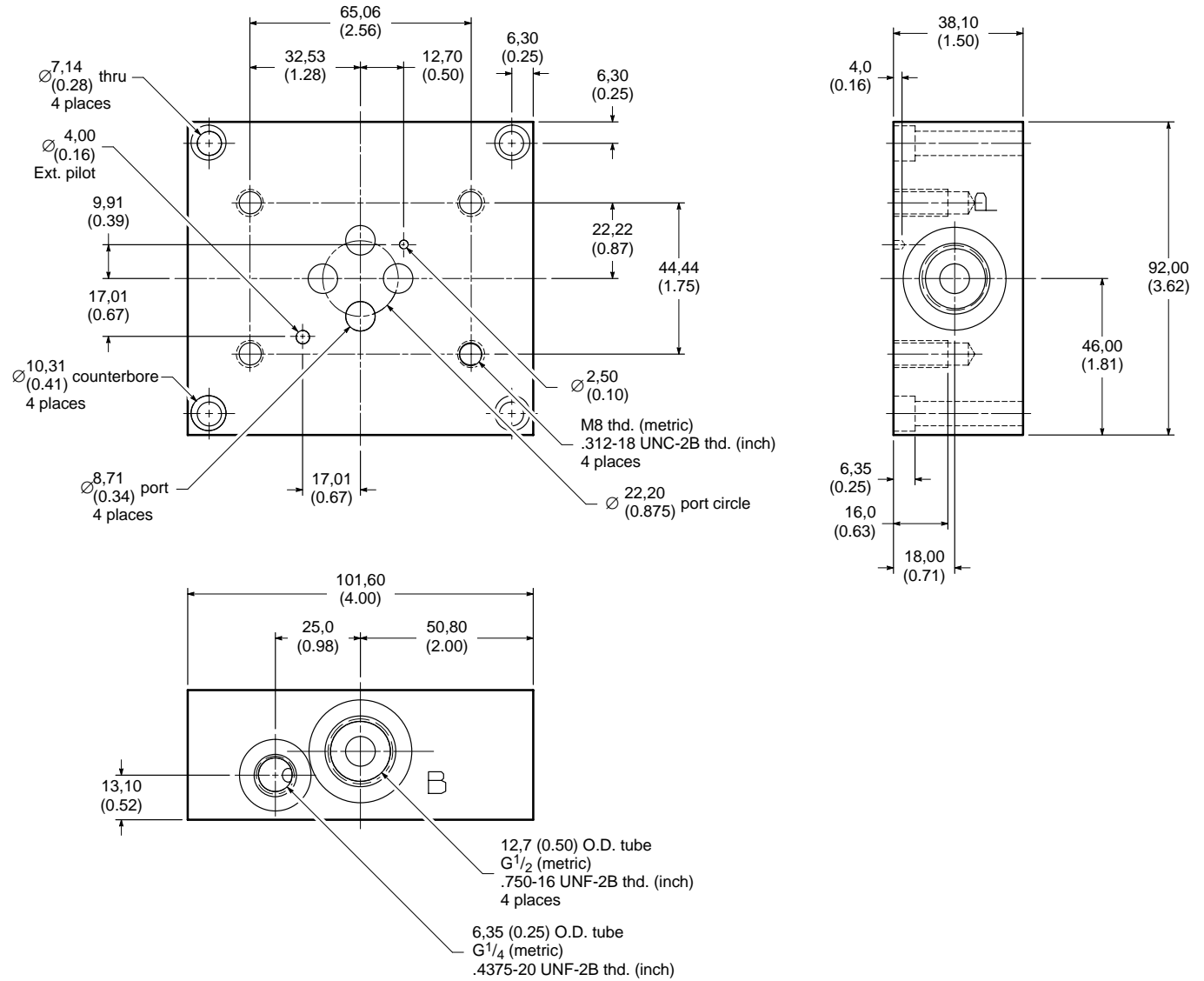

SM4A Adapter Manifolds

Model Code

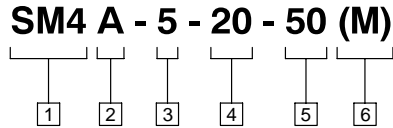

1 Series designation

SM4 – Servovalve, high performance, four-way

2 Accessory designation

A – Adapter manifold. Maximum supply pressure of 350 bar (5000 psi).

3 Interface

5 – ISO 4401-05

4 Standard SM4 valve size

20 – SM4-20

5 Design number

Subject to change. Installation dimensions same for designs 50 through 59.

-50 design indicates 350 bar (5000 psi) maximum supply pressure.

6 Metric suffix

M – Metric version to NG (ISO) standards

Blank – Omit if not required

Installation Dimensions

millimeters (inches)

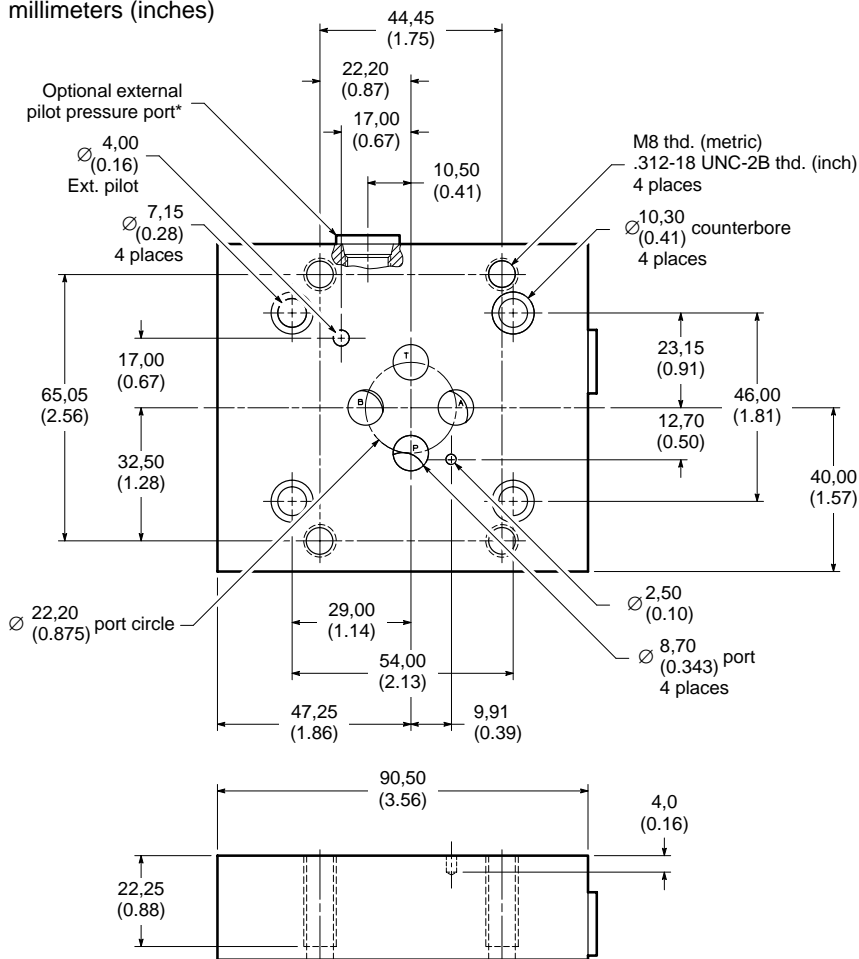

* - 6,35 (0.25) O.D. tube
 G¹/₄ (metric)
 .4375-20 UNF-2B thd. (inch)

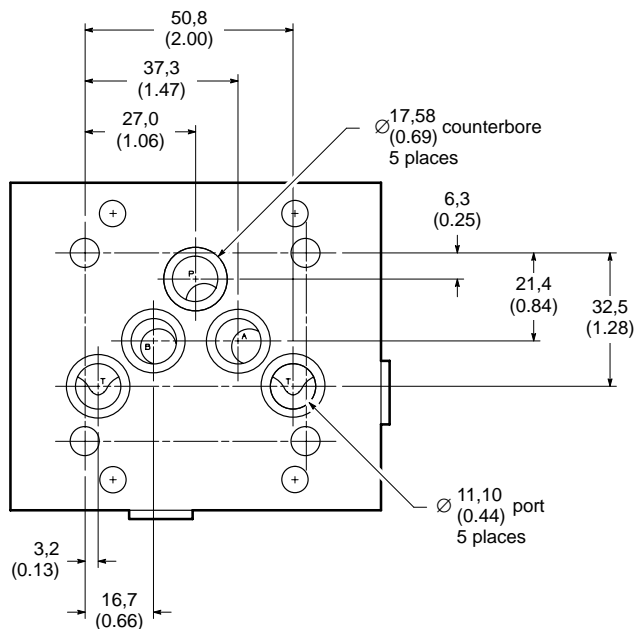

SM4FV Flushing Valves

Model Code

SM4 FV - 20 - 10

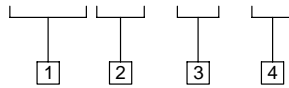

1 Series designation

SM4 – Servovalve, high performance, four-way

2 Accessory designation

FV– Flushing valve. Maximum flushing pressure of 35 bar (500 psi).

4 Design number

Subject to change. Installation dimensions same for designs 10 through 19.

3 Standard SM4 valve size

20 – SM4-20

Installation Dimensions

millimeters (inches)

SM4FV-20-10

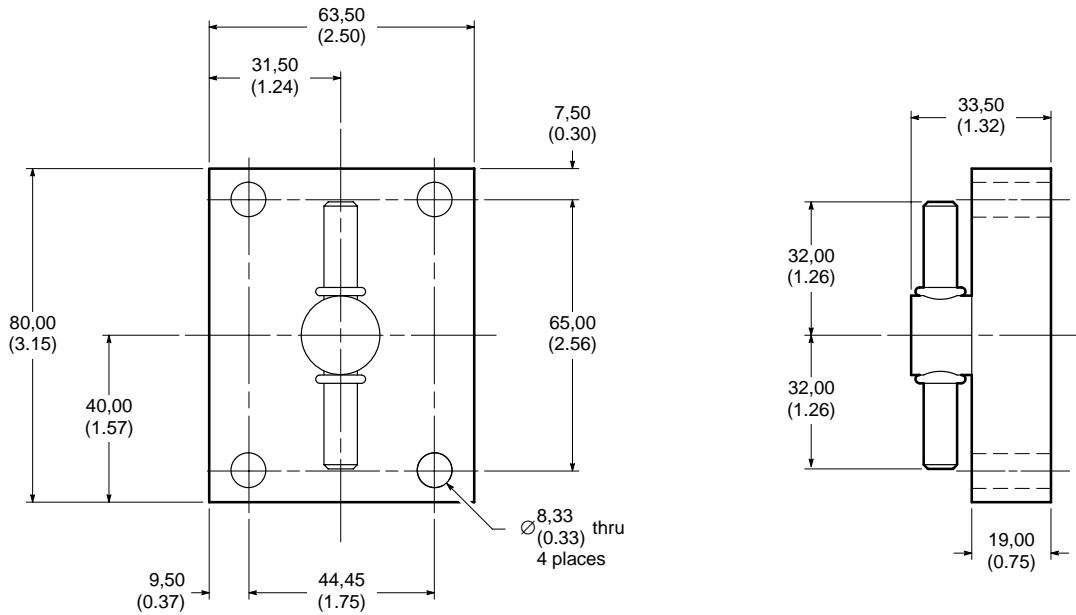

SM4FM Filter Modules

Model Code

SM4 FM - 20 - (CB) - 50

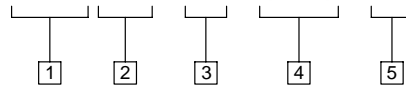

1 Series designation

SM4 – Servovalve, high performance, four-way

3 Standard SM4 valve size

20 – SM4-20

5 Design number

Subject to change. Installation dimensions same for designs 50 through 59.

2 Accessory designation

FM – Filter module. Maximum supply pressure of 350 bar (5000 psi).

4 Crossport bleed designation

CB – Includes crossport bleed feature
Blank – Omit if not required

-50 design indicates 350 bar (5000 psi) maximum supply pressure.

Installation Dimensions

millimeters (inches)

SM4FM-20-50

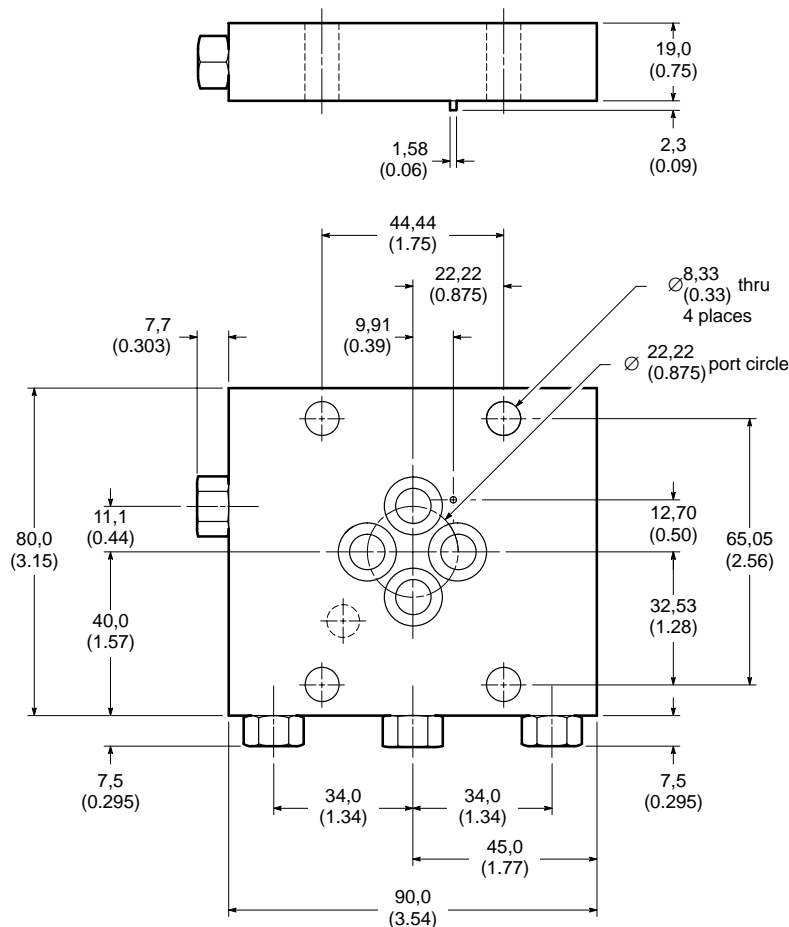

Weights

The following table lists approximate dry weights for the SM4-20 (-50 design) and related accessories.

Description	Model Code	Weight kg (lbs.)
Servo valve	SM4-20 (-50 design)	2,1 (4.6)
Mounting subplate	SM4M(E)-20-50(M)	0,91 (2.0)
Adapter manifold	SM4A-5-20-50(M)	0,44 (0.97)
Flushing valve	SM4FV-20-10	0,27 (0.58)
Filter module	SM4FM-20-(CB)-50	0,73 (1.6) est.

Additional Accessories

SM4-20 (-50 design) Accessories	Model Code
Adapter manifold mounting bolt kit (inch) $1/4-20 \times 1"$	BK866686
Adapter manifold mounting bolt kit (metric) M6 x 25mm	BK689629M
Cable clamp (MS3057-6)	126058
Cable connector (MS3106-14S-2S)	242123
Connector kit	926467
Cross-port bleed module mounting bolt kit (inch) $5/16-18 \times 2^{3/4}"$	BK855421
Filter kit	926469
Filter module kit	886819
Filter module mounting bolt kit (inch) $5/16-18 \times 2^{3/4}"$	BK855421
Filter module mounting bolt kit (metric) M8 x 70mm	BK689624M
Filter module with cross-port bleed mounting bolt kit (inch) $5/16-18 \times 3^{1/4}"$	BK927736
Flushing valve mounting bolt kit (inch) $5/16-18 \times 1^{1/4}"$	BK688701
Flushing valve mounting bolt kit (metric) M8 x 35mm	BK689630M
Seal kit (SM4-20)	920320
Subplate mounting bolt kit (inch) $1/4-20 \times 1^{1/2}"$	BK855992
Subplate mounting bolt kit (metric) M6 x 40mm	BK855993M
Valve mounting bolt kit (inch) $5/16-18 \times 2"$	BK866687
Valve mounting bolt kit (metric) M8 x 50mm	BK866690M

Servo Electronics

See application brochure 656 for the complete Vickers line of amplifiers, power supplies, and function modules.

Application Data

Fluid Cleanliness

Proper fluid condition is essential for long and satisfactory life of hydraulic components and systems. Hydraulic fluid must have the correct balance of cleanliness, materials, and additives for protection against wear of components, elevated viscosity and inclusion of air.

Essential information on the correct methods for treating hydraulic fluid is included in Vickers publication 561 "Vickers Guide to Systemic Contamination Control," available from your local Vickers distributor or by contacting Vickers, Incorporated. Recommendations on filtration and the

selection of products to control fluid condition are included in 561.

Recommended cleanliness levels, using petroleum oil under common conditions, are based on the highest fluid pressure levels in the system and are coded in the chart below. Fluids other than petroleum, severe service cycles, or temperature extremes are cause for adjustment of these cleanliness codes. See Vickers publication 561 for exact details.

Vickers products, as any components, will operate with apparent satisfaction in fluids with higher cleanliness codes than those described. Other manufacturers

will often recommend levels above those specified. Experience has shown, however, that life of any hydraulic component is shortened in fluids with higher cleanliness codes than those listed below. These codes have been proven to provide a long, trouble-free service life for the products shown, regardless of the manufacturer.

NOTE

Vickers will extend, by one year, the standard warranty on all Vickers products used in a system protected by Vickers filters (and elements) applied in a manner consistent with the principles presented in Vickers publication 561.

Product	System Pressure Level		
	psi		
	<2000	2000–3000	3000+
Vane pumps, fixed	20/18/15	19/17/14	18/16/13
Vane pumps, variable	18/16/14	17/15/13	
Piston pumps, fixed	19/17/15	18/16/14	17/15/13
Piston pumps, variable	18/16/14	17/15/13	16/14/12
Directional valves	20/18/15	20/18/15	19/17/14
Proportional valves	17/15/12	17/15/12	15/13/11
Servo valves	16/14/11	16/14/11	15/13/10
Pressure/Flow controls	19/17/14	19/17/14	19/17/14
Cylinders	20/18/15	20/18/15	20/18/15
Vane motors	20/18/15	19/17/14	18/16/13
Axial piston motors	19/17/14	18/16/13	17/15/12

Eaton Hydraulics

15151 Highway 5
Eden Prairie, MN 55344
Telephone: 612 937-7254
Fax: 612 937-7130
www.eatonhydraulics.com

46 New Lane, Havant
Hampshire PO9 2NB
England
Telephone: (44) 170-548-6451
Fax: (44) 170-548-7110

